

TAC 41

Polymer

user manual



SILVERBACK
AIRSOFT



TAC 41

Polymer



TABLE OF CONTENT

SAFETY.....	4
WARNINGS.....	4
BOX CONTENT.....	5
GUN DESCRIPTION.....	5
BOLT ASSEMBLY.....	6
SAFETY OPERATION.....	7
MAGAZINE OPERATION.....	7
FEEDING RAMP INITIALIZATION.....	8
SHOOTING OPERATION.....	8
FEEDING RAMP RESET.....	9
HOPUP ADJUSTMENT.....	10
ADVANCED SETTINGS & ERGONOMICS.....	11
EXPLODED VIEWS.....	12
MATERIALS/MASS/SIZE/CAPACITY.....	13
SERIAL NUMBER.....	14
NOTES.....	14



TMC

SAFETY

READ THIS MANUAL CAREFULLY AND THOROUGHLY BEFORE USE, users should obey to laws regarding the usage and ownership of airsoft guns in their country. Misuse or careless use may cause serious injuries. Always treat airsoft guns as if they are loaded and with the same respect as you would treat firearms. Do not look into an airsoft gun muzzle. Never point the airsoft gun at something you do not intend to shoot. Users should always wear safety glasses. Always carry the airsoft gun in a bag or a case and never display it in public places. Always keep the airsoft gun in "safe" mode until you are ready to shoot at a safe direction. Always check that the airsoft gun is in "safe" mode and unloaded when getting it from another person or from storage. Do not put the airsoft gun away or in storage while it is still loaded. Do not shoot at hard surfaces or water surfaces as BBs could bounce or ricochet and hit someone or something you do not intend to hit. Always use high quality 6 mm plastic BBs and never use already shot BBs as it may damage your airsoft gun. Always store airsoft guns in a secure place and out of reach from children. Do not attempt to modify or alter your airsoft guns, as doing so may make your airsoft gun unsafe to use and/or cause serious injuries and/or void the warranty. **WE ARE NOT RESPONSIBLE FOR ANY MALFUNCTIONS, ACCIDENTS, INJURIES OR REPAIR COSTS RESULTING FROM MISUSE, DISASSEMBLY AND/OR MODIFICATION OF THIS AIRSOFT GUN.**



WARNINGS

- The feeding ramp can hold 20 BBs, that means the Tac-41 is able to shoot without a magazine.
- Do not pull the trigger while the bolt is not locked or you will damage the receiver.
- During changing magazine, if you remove the magazine while it's not empty, you will lose 2 bbs. To avoid losing any bbs, remove the magazine only when it's empty.
- Do not loosen the 3 barrel screws too much while changing the barrel or you will deform the stock.
- In case of inner barrel disassembly, do not overtighten the lateral screws or you will damage the inner barrel.
- It is almost impossible to remove the hopup rubber without tearing it: do not attempt to disassemble the hopup rubber if you are not going to replace it.
- Using the trigger adjustments at maximum will generate safety problems and slamfire problems.
- Do not overload the magazine or you may damage the magazine.
- Maximum torque for the 3 barrel screws is 4 Nm.
- For storage, empty the feeding ramp and keep the steel parts greasy to avoid rusting.
- Do not apply any grease/oil inside the hopup and/or the barrel.
- Keep the bolt closed during barrel changes to ensure perfect bolt and barrel alignment.
- Make sure no BBs remain in the hopup and the feeding ramp before removing the barrel.



BOX CONTENT

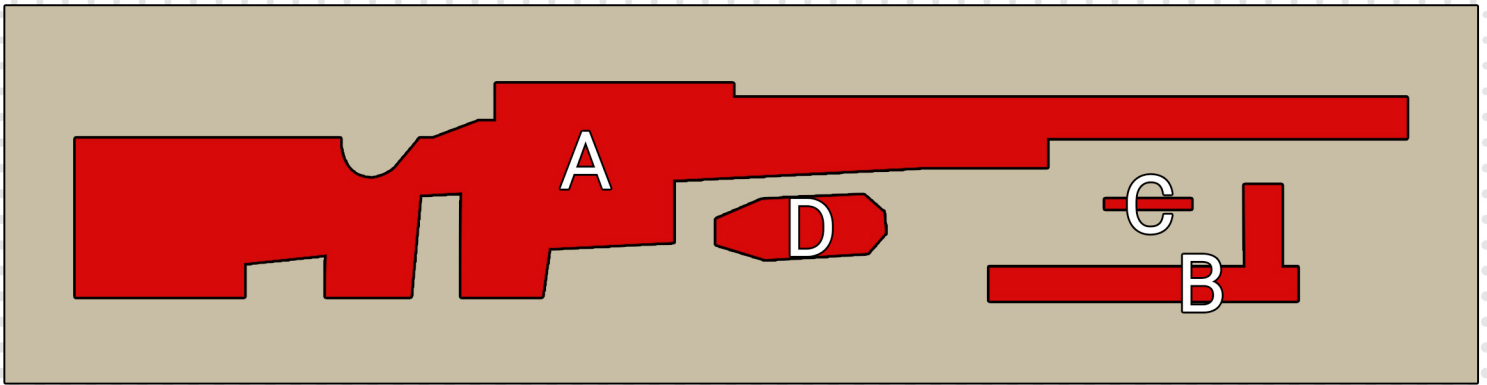

- A: Tac 41 & short magazine (engaged)
- B: Bolt
- C: Spring guide stopper
- D: Buttplate spacers

GUN DESCRIPTION

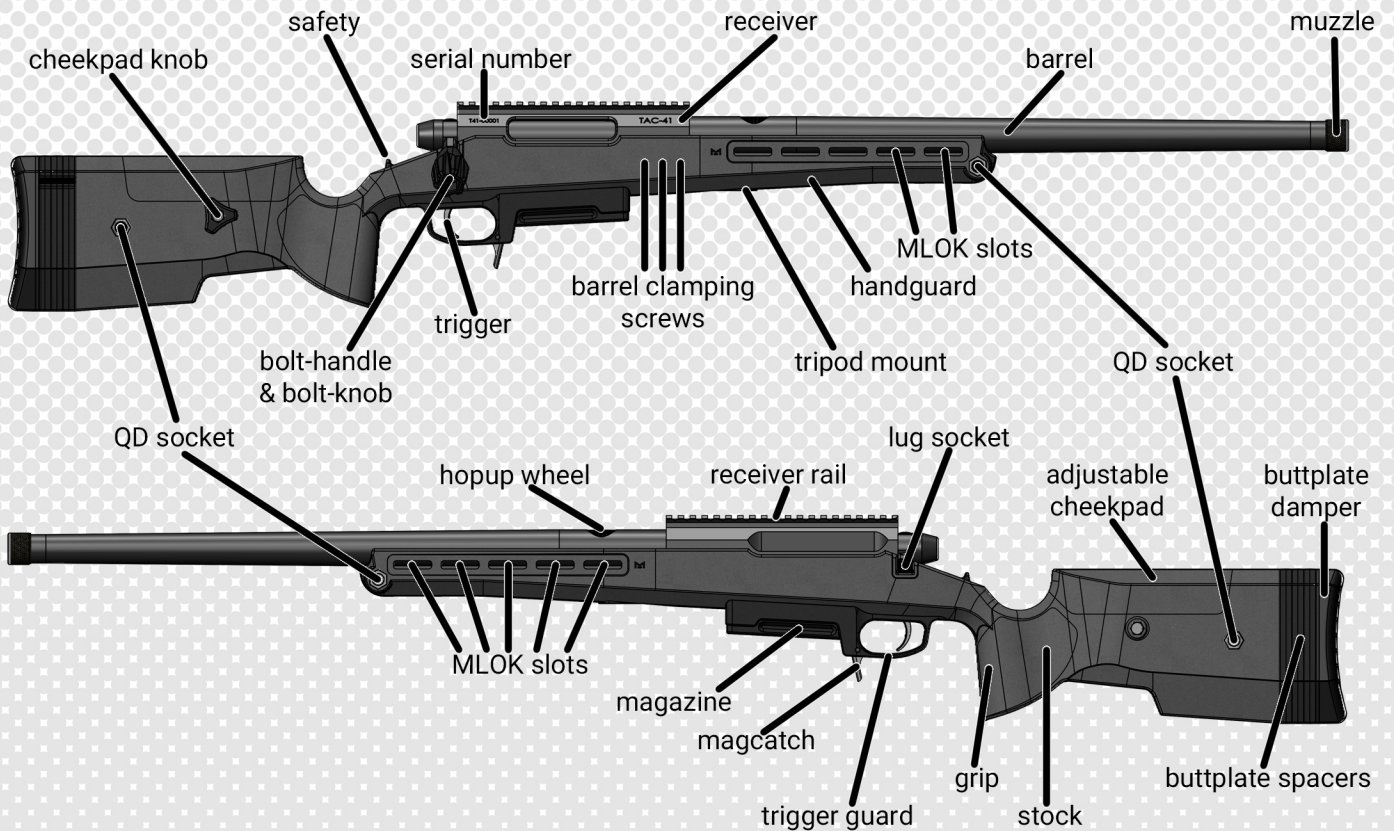

BOLT ASSEMBLY

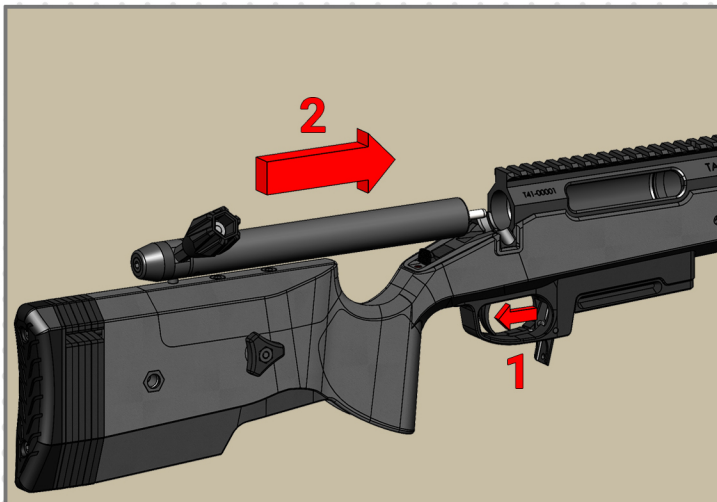

While pulling the trigger, slide the bolt into the receiver. Make sure that the slot on the cylinder and the bolt lug are facing downwards.

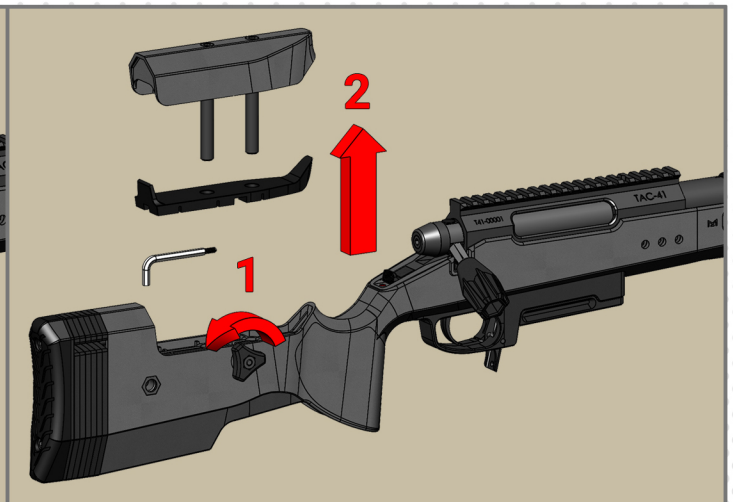

Loosen the cheekpad knob and remove the cheekpad by lifting it up, then pull out the rubber plug and take out the threaded tool.

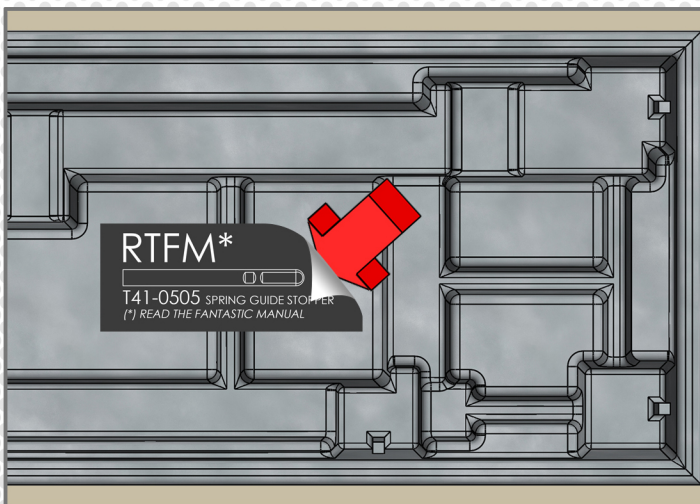

Now go to the packaging and locate the spring guide stopper under the RTFM sticker.

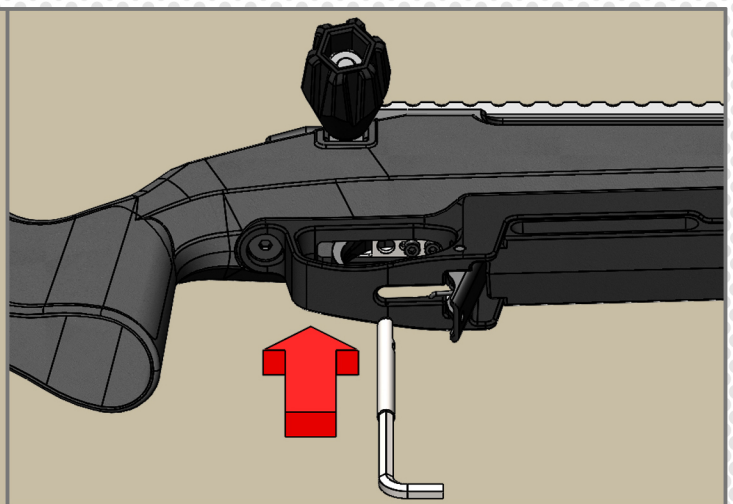

Thread the tool into the spring guide stopper. Insert the spring guide stopper into the gun as shown. The flat surface of the spring guide stopper needs to face towards the front of the gun.

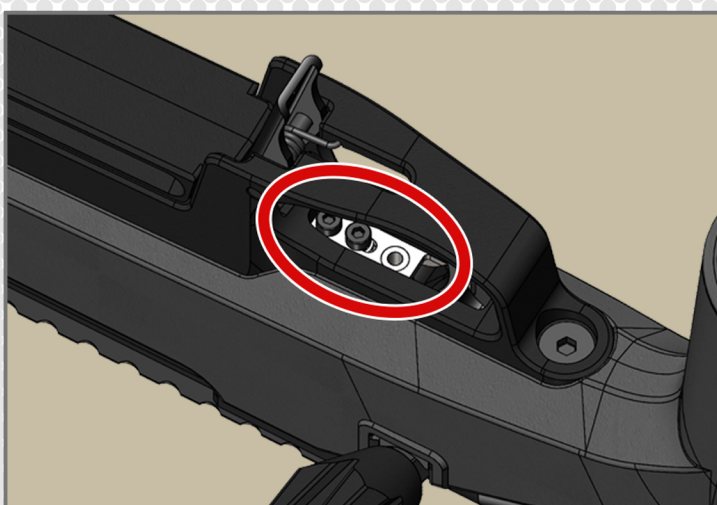

The spring guide stopper is properly installed when you hear a click and the bottom is flat against the trigger box as shown. If you cannot engage the piston sear, your spring guide stopper is probably facing the wrong direction.

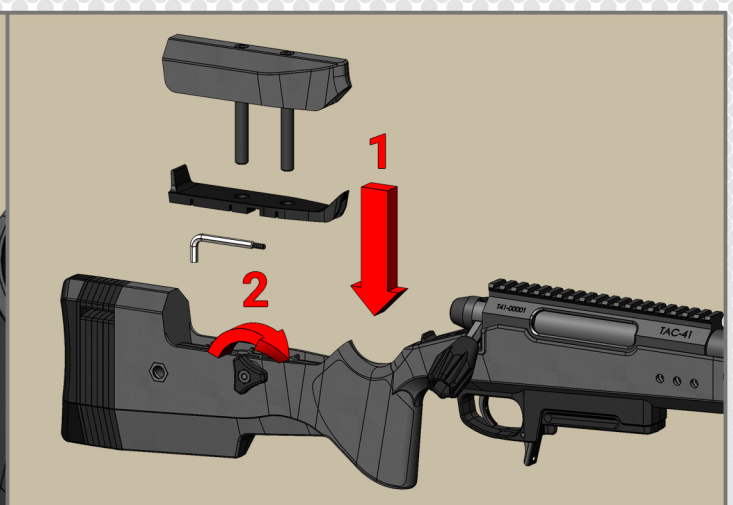

Put the tool, the rubber cover (for easier fit, engage firstly the front of the rubber cover into the stock before to engage the back side) and the cheekpad back into place. Then tighten the cheekpad knob again.

SAFETY OPERATION

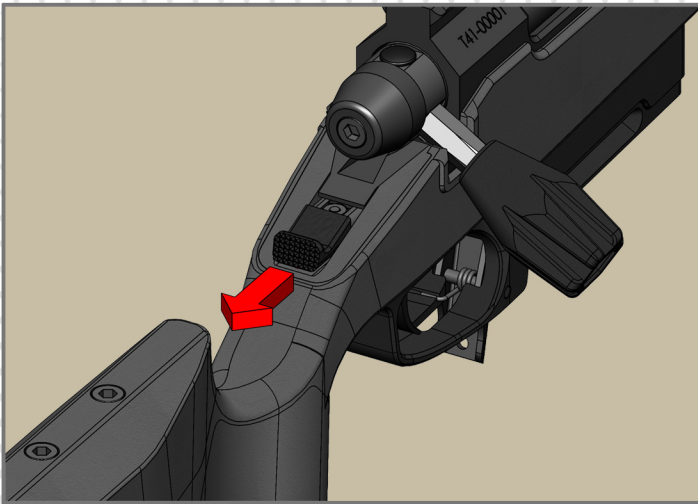

Slide the safety button towards the back to engage safety. Safety engagement may be firm when the rifle is new.

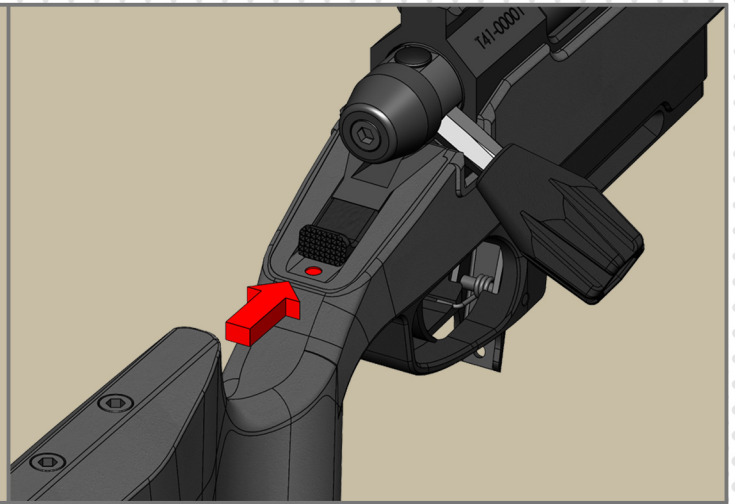

Slide the safety button towards the front (red dot appears) to disengage the safety.

MAGAZINE OPERATION

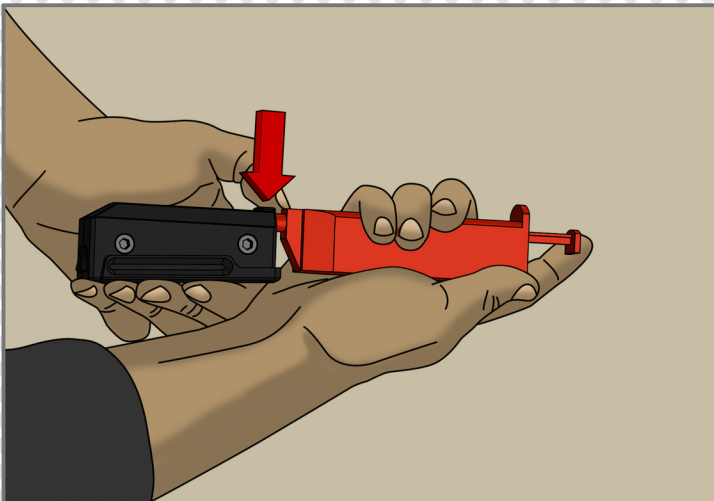

Fill the magazine with 6mm bbs, preferably using a bb loader. You will need to press on the magazine gate (as shown) to load the magazine. Magazine capacity: 48 bbs.



Insert the magazine as shown.

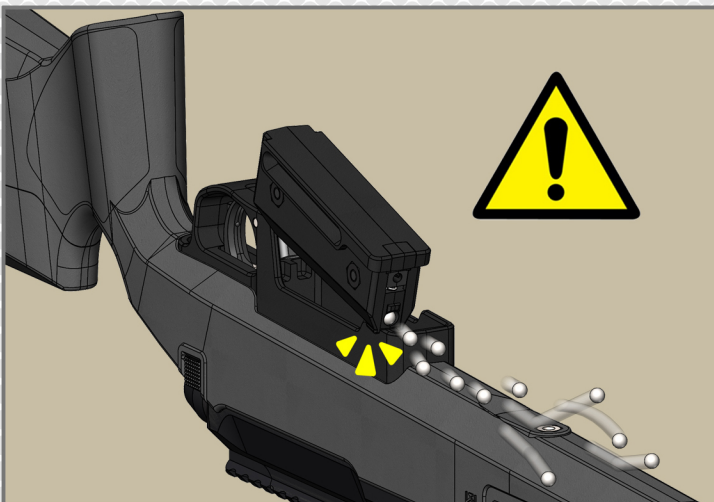

When engaging the magazine, be careful not to hit the mag gate on to the trigger guard, or else all the bbs will burst out of the magazine.



To disengage the magazine, push forward the magcatch and let the magazine drop by gravity.

FEEDING RAMP INITIALIZATION



Engage a loaded magazine to pre-fill the feeding ramp (20 bbs are required).



Disengage the magazine.

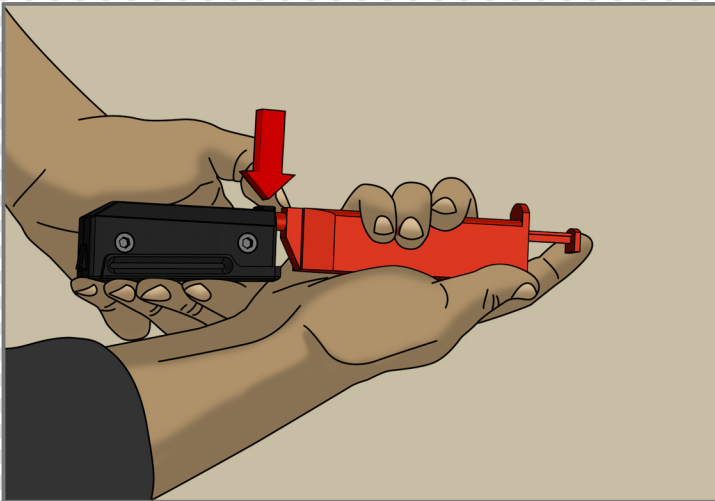

Refill the magazine.

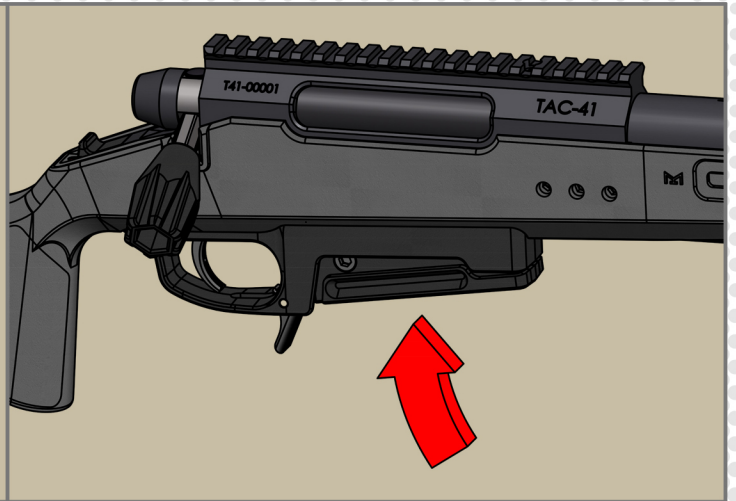

Re-engage the magazine. Your TAC-41 is now ready to shoot.

SHOOTING OPERATION

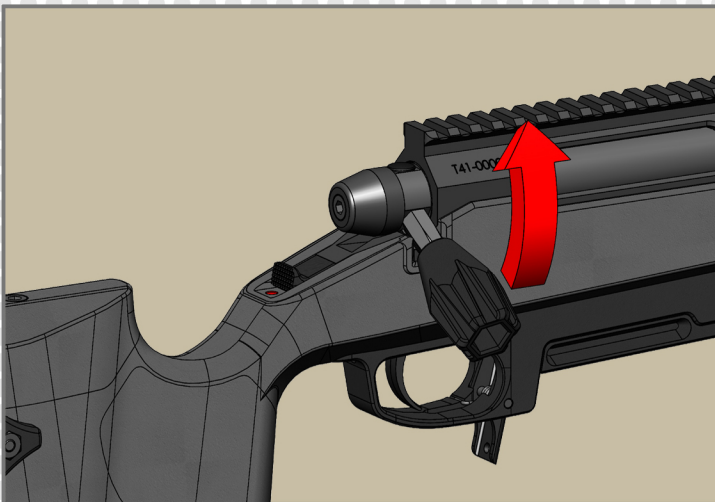

Lift up the bolt handle (make sure the bolt is not already loaded to avoid double feeding).

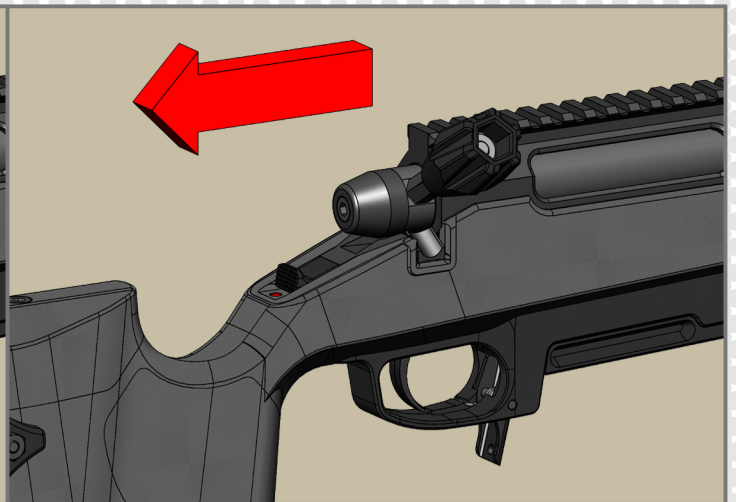

Pull the bolt backwards to compress the spring and lock the piston sear (until it clicks).

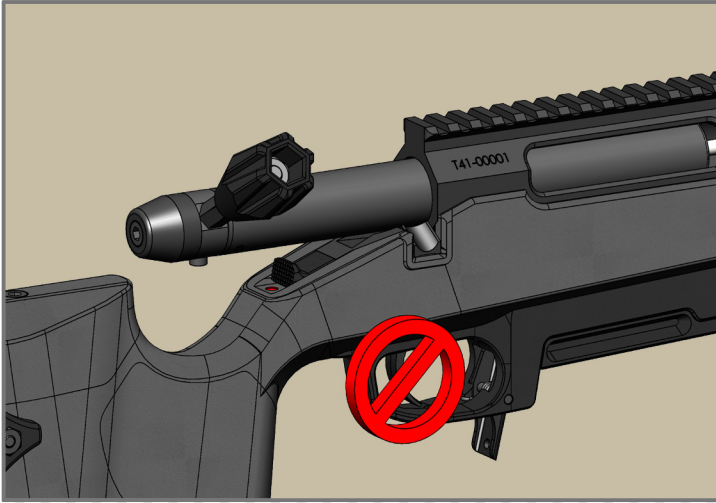

Make sure not to pull the trigger by accident when the bolt is pulled back.

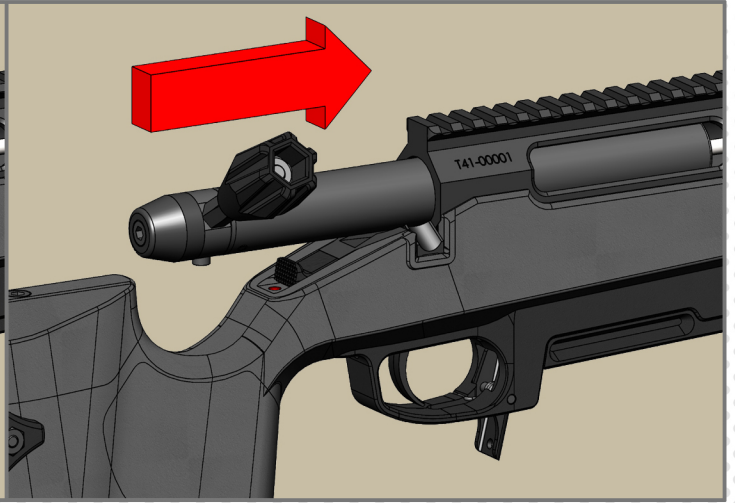

Push the bolt forward to engage a BB inside the hopup.

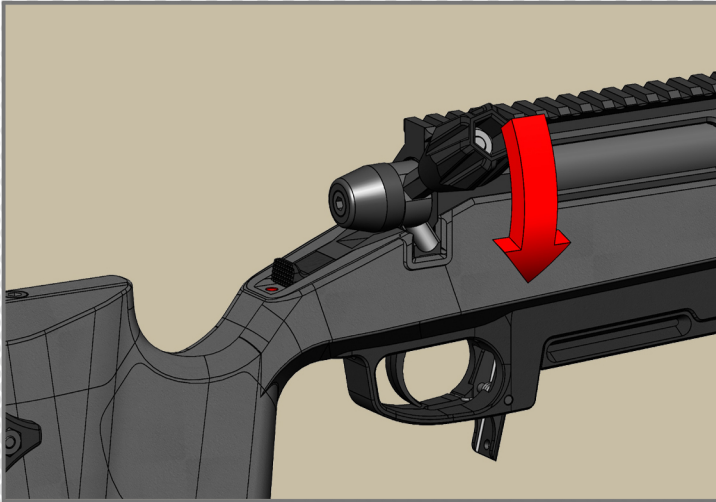

Lower the bolt handle to lock the bolt.

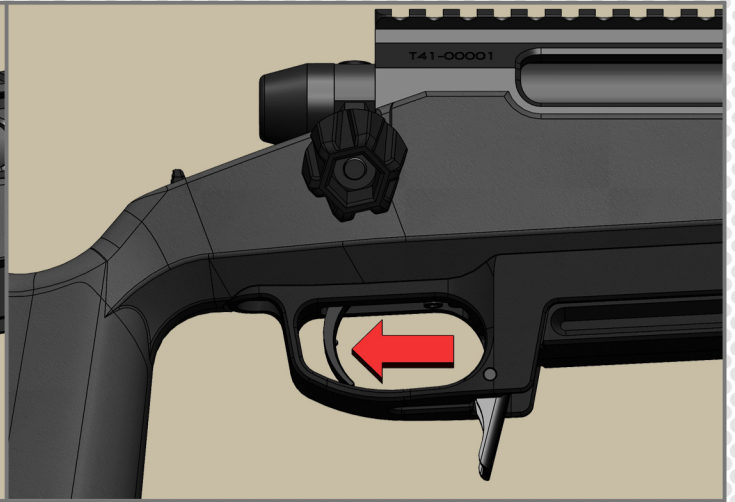

Pull the trigger to shoot. (Make sure that the safety is disengaged).

FEEDING RAMP RESET



Disengage the magazine.

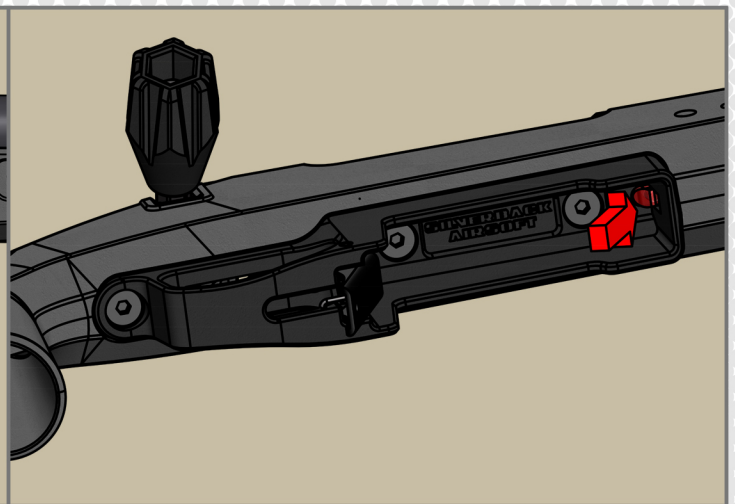

Press the feeding ramp stopper to release all the BBs inside the feeding ramp by gravity (tilt the gun at an angle with the muzzle facing upward and the trigger guard facing downward).

HOPUP ADJUSTMENT

Each «click» is increasing/decreasing the hopup preload by 15 μm . There is 50 positions for the hopup wheel, ranging from 0 up to 750 μm .

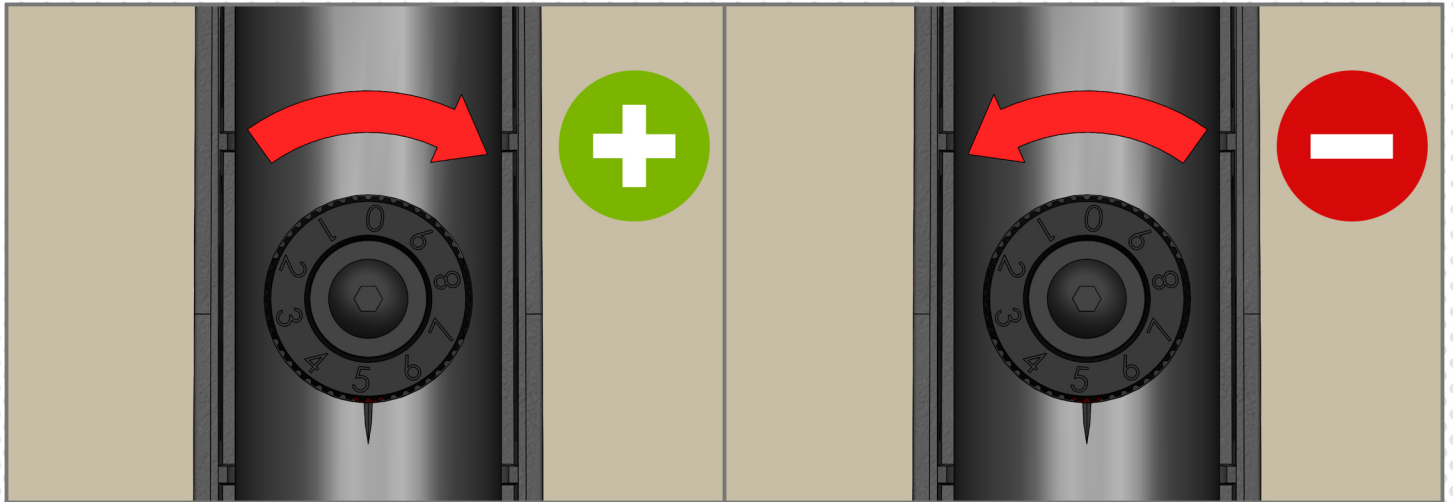

Turn the Hopup in clockwise direction to increase Hopup effect.

Turn the Hopup in counterclockwise direction to reduce Hopup effect.

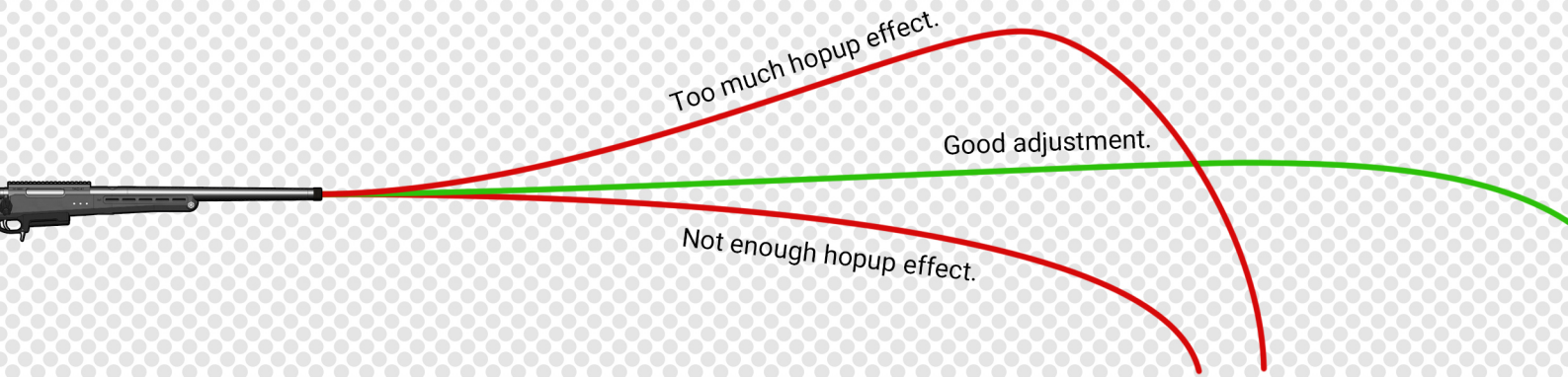

WARNINGS

- Hopup adjustment needs to be done every time you change the BBs mass or the muzzle energy.
- Excessive hopup adjustment will jam the gun.
- In case of jam
 1. remove the magazine,
 2. turn the hopup wheel to «0»,
 3. cycle the bolt,
 4. shoot in a safe direction.
- Hopup adjustment may affect your muzzle energy: always check your muzzle energy after adjusting your hopup using in-game bbs and make sure it is within the limits of your local law/rules.
- It is mandatory to keep your hopup clean and dry to be effective.
- You can switch from the position «9» to the position «0», but you cannot do the opposite.
- To avoid any sidespin, be sure to hold your rifle straight before to pull the trigger.



ADVANCED SETTINGS & ERGONOMICS

To help you with the ergonomic and advance settings, please check out our YouTube channel for the tutorials. Scan the QR code on this page to access our YouTube channel.

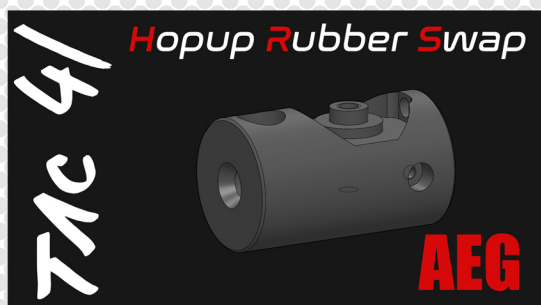
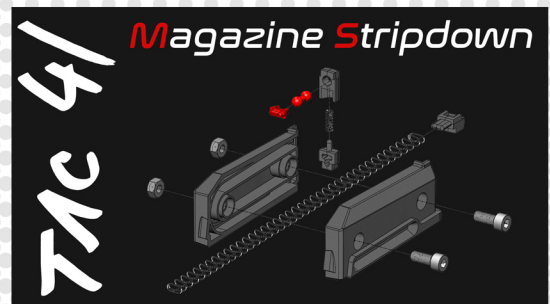
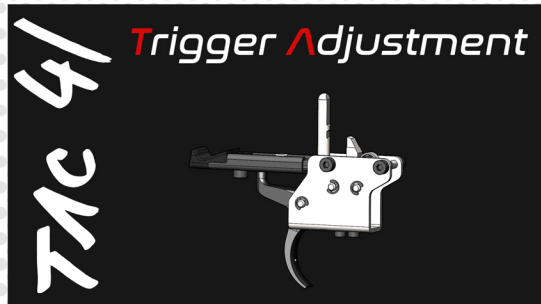



EXPLODED VIEWS

Scan this QR code to access the detailed exploded views.

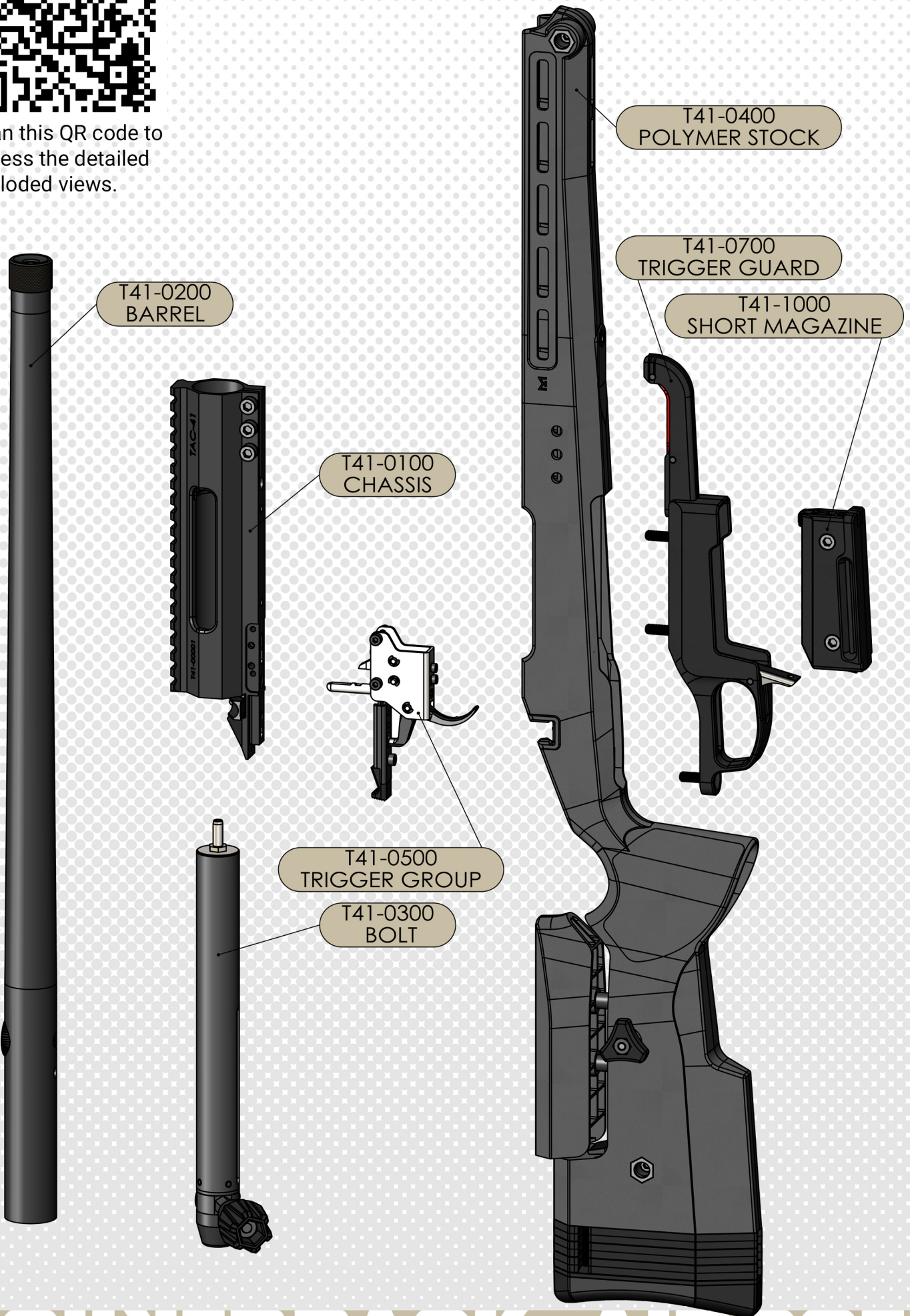

MATERIALS / MASS / SIZE / CAPACITY

	Receiver	Outer Barrel	Inner Barrel	Hopup	Bolt	Stock	Cheekpad	Buttplate	Trigger Box	Spring Guide Stopper	Safety	Trigger Guard	Magcatch	BB Feeding Ramp	Short magazine	Screws	O-rings
Aluminium 6000 Series	■	■		■	■	■	■										
Aluminium ADC-12									■								
Steel CR1018					■	■					■	■	■				
Stainless Steel SS304					■				■	■							
Steel 10.9																■	
Brass			■														
Nylon PA6-GF15				■	■	■	■	■			■	■			■		
ABS				■					■						■		
PC													■				
NBR					■	■		■									■
Silicon 60°				■													

CATEGORY #	CATEGORY NAME	[gram]
T41-0100	CHASSIS	349
T41-0200	BARREL	486
T41-0300	BOLT	474
T41-0400	POLYMER STOCK	1191
T41-0500	TRIGGER GROUP	126
T41-0700	TRIGGER GUARD	116
T41-1000	SHORT MAGAZINE	79
T41-0000-P	TOTAL	2821
<i>Mass tolerances: +/- 0.2 %</i>		

SIZE	[mm]
T41-P minimum size:	1095
T41-P maximum size with 6 buttplate spacers (3 pcs. included):	1155
T41-P inner barrel (AEG type) length:	510
<i>Size tolerance: +/- 0.2 %</i>	

CAPACITY	[bbs]
Short magazine	48
Feeding ramp	20

SERIAL NUMBER

T41 -

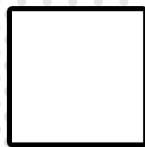

BLACK

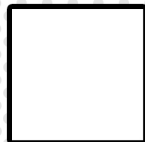

FLAT DARK EARTH

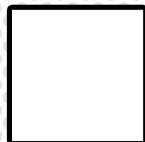

OLIVE DRAB

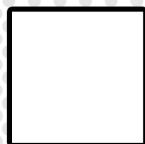

WOLF GREY

NOTES:

You may scan this QR code and download the digital version of this user manual. In case of user manual update, this link will provide you with the latest version. If you wish to contact us regarding your TAC-41 or receive news about this product line, please contact us at info@silverback-airsoft.com with your serial number as reference

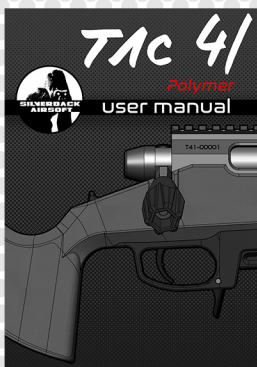





September 2021 - Made in China

SILVERBACK AIRSOFT